

TAS5162DDV6EVM

This user's guide describes the operation of the evaluation module for the TAS5162 Digital Amplifier Power Output Stage using the TAS5086 Digital Audio PWM Processor from Texas Instruments. The user's guide also provides measurement data and design information such as the schematic, bill of materials, and printed-circuit board layout

Contents

1	Overview	3
2	Quick-Setup Guide	5
3	Protection	7
4	TAS5162DDV6EVM Performance.....	9
5	Related Documentation from Texas Instruments	20
Appendix A	Design Documents	22

List of Figures

1	TAS5162DDV6EVM Board	3
2	Integrated PurePath Digital™ Amplifier System	4
3	Physical structure for the TAS5162DDV6EVM (Approximate Layout).....	5
4	TAS5518 GUI Window	7
5	THD+N vs Power (SE – 4 Ω).....	11
6	THD+N vs Power (SE – 3 Ω)	11
7	THD+N vs Power (BTL – 8 Ω).....	12
8	THD+N vs Power (BTL – 6 Ω).....	12
9	THD+N vs Frequency (SE – 4 Ω)	13
10	THD+N vs Frequency (SE – 3 Ω)	13
11	THD+N vs Frequency (BTL – 8 Ω).....	14
12	THD+N vs Frequency (BTL – 6 Ω).....	14
13	FFT Spectrum With –60 dBFS Tone (SE)	15
14	FFT Spectrum With –60-dBFS Tone (BTL).....	15
15	Idle Noise FFT Spectrum (SE)	16
16	Idle Noise FFT Spectrum (BTL)	16
17	Channel Separation	17
18	Frequency Response (BTL).....	17
19	Frequency Response (BTL).....	18
20	High Current Protection (SE)	18
21	High Current Protection (PBTL)	19
22	Pop/Click (BTL)	19
23	Pop/Click (SE)	20
24	Output Stage Efficiency	20

List of Tables

1	TAS5162DDV6EVM Specification	3
2	Recommended Supply Voltages.....	6
3	TAS5162 Warning/Error Signal Decoding.....	8
4	General Test Conditions	9

PurePath Digital, Equibit are trademarks of Texas Instruments.
 Windows is a trademark of Microsoft Corporation.
 I²C is a trademark of Philips Electronics.

5	TAS5086 Register Settings.....	9
6	Electrical Data	9
7	Audio Performance.....	10
8	Thermal Specifications	10
9	Physical Specifications	10
10	Related Documentation from Texas Instruments	21

PurePath Digital, Equibit are trademarks of Texas Instruments.
Windows is a trademark of Microsoft Corporation.
I²C is a trademark of Philips Electronics.

1 Overview

The TAS5162DDV6EVM PurePath Digital™ customer evaluation module (Figure 1) demonstrates the integrated circuits TAS5162DDV and TAS5086DBT from Texas Instruments (TI).

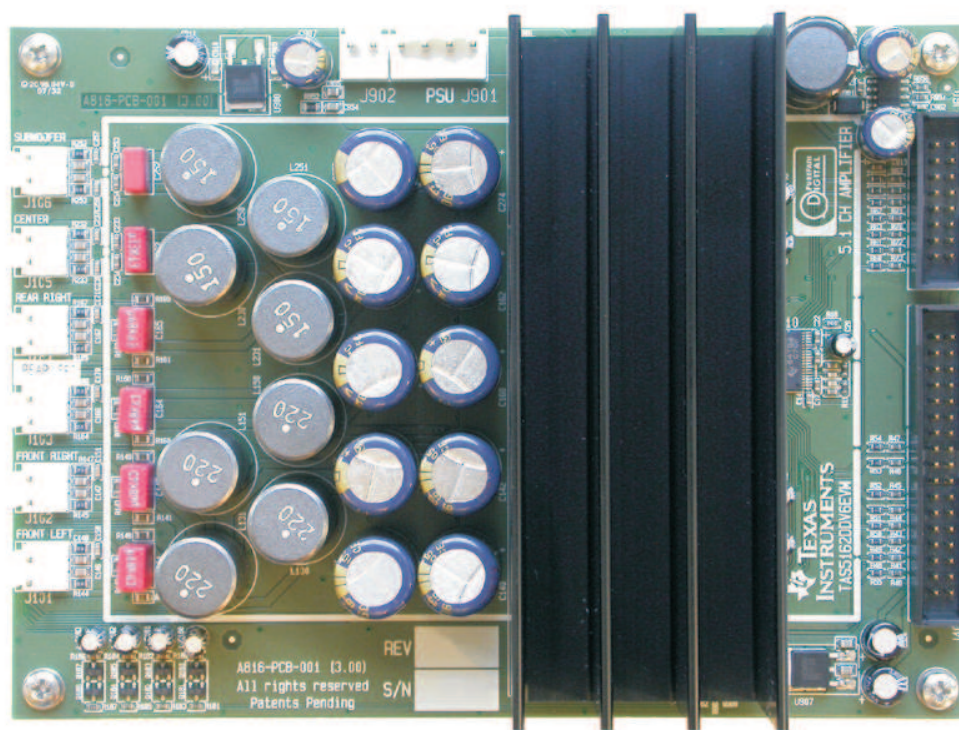

Figure 1. TAS5162DDV6EVM Board

The TAS5162DDV is a high-performance, integrated stereo digital amplifier power stage designed to drive 6- Ω speakers at up to 210 W per channel. The device incorporates PurePath Digital™ technology and is designed to be used with PurePath Digital™ modulators (Figure 2). This system requires only a simple, passive demodulation filter to deliver high-quality, high-efficiency audio amplification.

TAS5086DBT is a high-performance, 32-bit (24-bit input), multichannel PurePath Digital™ pulse width modulator (PWM) based on Equibit™ technology with fully symmetrical analog-to-digital modulation scheme.

This EVM is configured with four single-ended (SE) channels and two bridge-tied load (BTL) channels.

This EVM, together with a TI input-USB board, is a complete 5.1 channels, digital audio amplifier system which includes digital input (S/PDIF), analog inputs, interface to PC and DAP features like digital volume control, input and output mixers, automute, tone controls, loudness, EQ filters, and dynamic range compression (DRC). Table 1 lists the key parameters of the EVM. There are configuration option for power stage failure protection and a mini-jack connector for headphone.

Table 1. TAS5162DDV6EVM Specification

Key Parameters	
Output Stage Supply Voltage:	0 V–50 V
System Supply Voltage:	15 V–20 V
Number of Channels	4 x SE, 2 x BTL
Load Impedance SE:	4–8 Ω
Load Impedance BTL:	6–8 Ω
Output power SE	80 W / 4 Ω 10% THD
Output power BTL	160 W / 8 Ω / 10% THD or 210 W / 6 Ω / 10% THD

Table 1. TAS5162DDV6EVM Specification (continued)

DNR	>109 dB
PWM Processor	TAS5086DBT
Output Stage	TAS5162DDV

This 6.1 system is designed for home theater applications such as A/V receivers, DVD receivers, DVD mini-component systems, or home theater in a box (HTIB).

This document covers EVM specifications, audio performance and power efficiency measurements graphs, and design documentation that includes schematics, parts list, layout, and mechanical design.

The EVM is delivered with cables and Input-USB board to connect to an input source and be controlled from a personal computer (PC).

1.1 TAS5162DDV6EVM Features

- 7/8-channel PurePath Digital™ evaluation module (double-sided, plated-through PCB layout).
- Self-contained protection system (short-circuit and thermal).
- Standard I²S and I²C™ / Control connector for TI input board
- Double-sided, plated-through PCB layout.

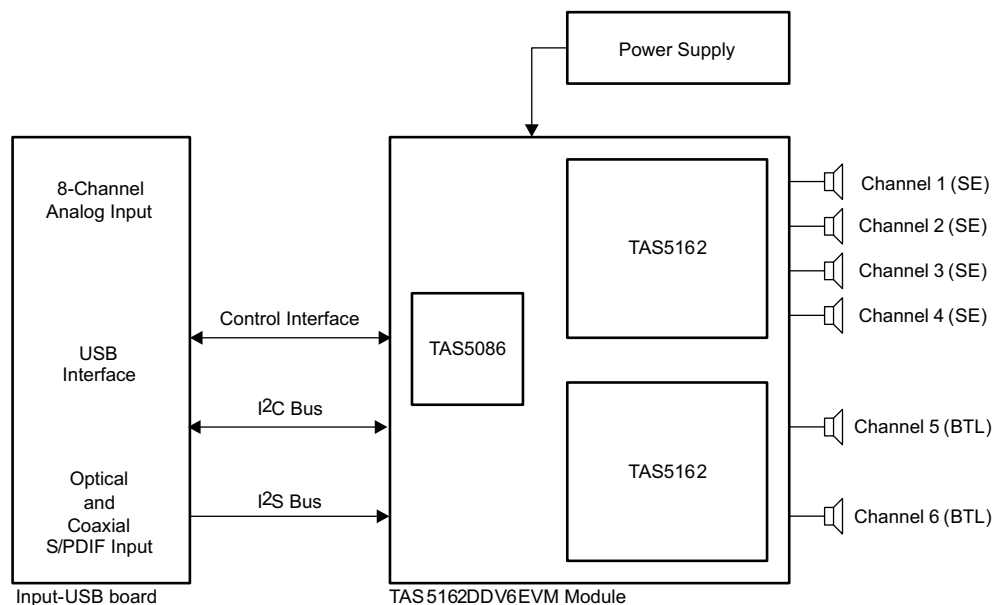

Figure 2. Integrated PurePath Digital™ Amplifier System

1.2 PCB Key Map

Physical structure for the TAS5162DDV6EVM is illustrated in [Figure 3](#).

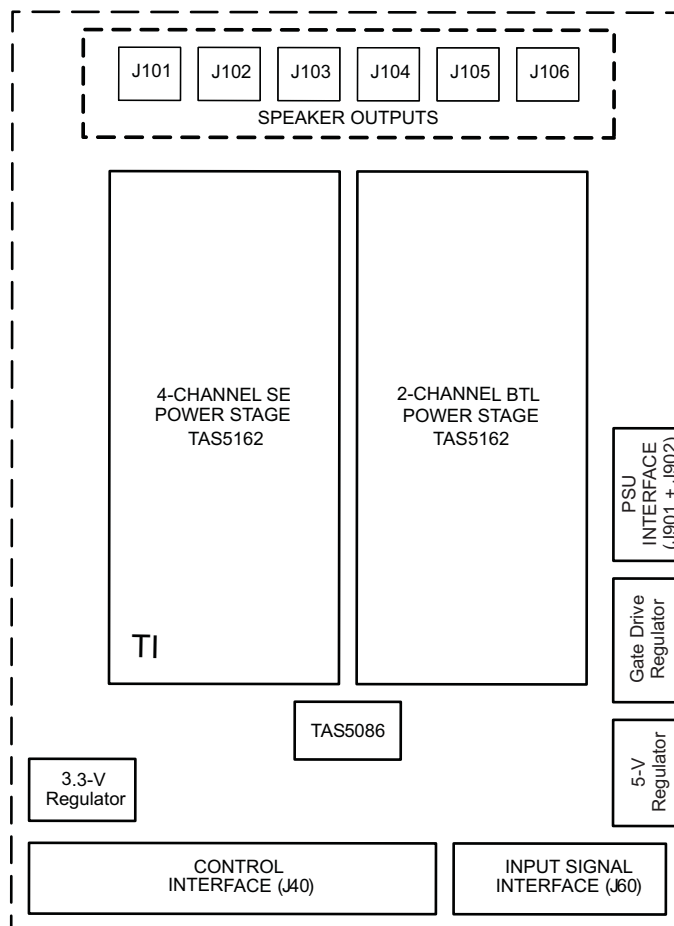

Figure 3. Physical structure for the TAS5162DDV6EVM (Approximate Layout)

2 Quick-Setup Guide

This section describes the TAS5162DDV6EVM board in regards to power supplies and system interfaces. The section provides information regarding handling and unpacking, absolute operating conditions, and a description of the factory default switch and jumper configuration.

This section provides a step-by-step guide to configuring the TAS5162DDV6EVM for device evaluation.

2.1 Electrostatic Discharge Warning

Many of the components on the TAS5162DDV6EVM are susceptible to damage by electrostatic discharge (ESD). Customers are advised to observe proper ESD handling precautions when unpacking and handling the EVM, including the use of a grounded wrist strap at an approved ESD workstation.

CAUTION

Failure to observe ESD handling procedures may result in damage to EVM components.

2.2 Unpacking the EVM

On opening the TAS5162DDV6EVM package, check to ensure that the following items are included:

- 1 pc. TAS5162DDV6EVM board using one TAS5086DBT and two TAS5162DDV.
- 1 pc. TI Input-USB board for interfacing TAS5162DDV6EVM with SPDIF/analog sources and PC for control.
- 1 pc. Signal Interface IDC cable for connection to an I²S front-end like the attached TI Input-USB board.
- 1 pc. Control Interface IDC cable for connection to an I²C™ front-end like the attached TI Input-USB board.
- 1 pc Cable for connecting Input-USB board to a USB port on a PC for TAS5086 control by software.
- 1 pc. Power supply cable for two regulated power supplies (H-bridge and system supply).
- 1 pc. PurePath Digital™ CD-ROM

If any of these items are missing, contact the Texas Instruments Product Information Center nearest you to inquire about a replacement.

Connect the Input-USB board to TAS5162DDV6EVM using the two delivered IDC cables.

2.3 Power Supply Setup

Two power supplies are required to power up the EVM: one for system power, logic, and gate-drive, and one for output stage supply. Power supplies are connected to the EVM using the delivered power cable Red/Black, White/Black.

Table 2. Recommended Supply Voltages

Description	Voltage Limitations	Current Requirement	Cable
System power supply	15–20 V	0.3 A	Red/Black
Output stage power supply	0–50 V	10 A	White/Black

CAUTION

Applying voltages above the limitations given in [Table 2](#) may cause permanent damage to the hardware.

Note: The length of power supply cable must be minimized. Increasing the length of the PSU cable is equivalent to increasing the distortion for the amplifier at high-output levels and low frequencies.

2.4 Speaker Connection

CAUTION

Both positive and negative speaker outputs are floating and may not be connected to ground (e.g., through an oscilloscope).

2.5 GUI Software Installation

The TAS5086 GUI provides easy control of all registers in the TAS5086. To install the GUI, run setup file from the PurePath™ CD-ROM.

After installation, turn on the power supplies and connect the USB cable to the Input-USB board.

Start GUI program from the Windows™ menu. Start up of GUI will take few seconds.



Figure 4. TAS5518 GUI Window

From the files menu, load the configuration file:

TAS5162DDV6EVM Configuration (3.00).cfg

The file is located on the PurePath™ CD-ROM. This file contains all settings for a default setup of the EVM.

For easy access of the file, it is recommended to copy the files into a directory where the GUI is installed. Default is C:\Program Files\Texas Instruments Inc\TAS5086\.

For more advanced use of the GUI, see the GUI user's guide and data sheet for the TAS5086.

3 Protection

This section describes the short-circuit protection and fault-reporting circuitry of the TAS5162 device.

3.1 Short-Circuit Protection and Fault-Reporting Circuitry

The TAS5162 is a self-protecting device that provides fault reporting (including high-temperature protection and short-circuit protection). TAS5162 is configured in back-end auto-recovery mode and therefore resets automatically after all errors (M1, M2, and M3 is set low); see the data sheet for further explanation. This means that the device restarts itself after an error occasion and reports shortly thereafter through the SD error signal.

3.2 Fault Reporting

The \overline{OTW} and \overline{SD} outputs from TAS5162 indicate fault conditions. See the TAS5162 data sheet for a description of these pins.

Table 3. TAS5162 Warning/Error Signal Decoding

\overline{OTW}	\overline{SD}	Device Condition
0	0	High-temperature error and/or high current error
0	1	High-temperature warning
1	0	Undervoltage lockout or high-current error
1	1	Normal operation, no errors/warnings

The temperature warning signals at the TAS5162DDV6EVM board are wired-OR to one temperature warning signal (\overline{OTW} – pin 22 in control interface connector). Shutdown signals are wired-OR into one shutdown signal (\overline{SD} – pin 20 in control interface connector).

The shutdown signals together with the temperature warning signal give chip-state information as described in [Table 3](#). Device fault-reporting outputs are open-drain outputs.

4 TAS5162DDV6EVM Performance

Table 4. General Test Conditions

General Test Conditions ⁽¹⁾		Notes
Output Stage Supply Voltage:	50 V	Laboratory Power Supply (EA-PS 7065-10A)
System Supply Voltage:	15 V	
Load Impedance SE:	4 Ω	
Load Impedance BTL:	8 Ω	
Input Signal	1 kHz Sine	
Sampling Frequency	48 kHz	
Gain Setting in TAS5086	0 dB	
Measurement Filter	AES17 and AUX0025	
TI Input-USB Board	Input-USB	Rev 10
EVM Configuration File	Ver 3.00	TAS5162DDV6EVM Configuration (3.00).cfg

⁽¹⁾ These test conditions are used for all tests, unless otherwise specified.

Table 5. TAS5086 Register Settings

Register ⁽¹⁾		Value	Notes
Oscillator Trim Register	0x1B	0x00	Initiate Factory Trim
Master Volume Register	0x07	0x30	Master Volume 0 dB
Split Cap Register	0x1A	0x00	No Split Capacitor Charge Period.
Modulation Index Limit Register	0x10	0x04	Set Modulation Index to 96.1%
PWM Start Register	0x18	0xF0	Mid-Z Sequence Enabled For All Channels.
Input Multiplexer Register	0x20	00 01 23 45	
Output Multiplexer Register	0x25	00 01 23 45	
System Control Register	0x05	20	PWM Start

⁽¹⁾ These register settings are used for all tests, unless otherwise specified.

Table 6. Electrical Data

Electrical Data		Notes/Conditions
Output Power, SE, 4 Ω :	60 W	1 kHz, Unclipped (0 dBFS), $T_A = 25^\circ\text{C}$
Output Power, SE, 4 Ω :	80 W	1 kHz, 10% THD+N, $T_A = 25^\circ\text{C}$
Output Power, BTL, 6 Ω :	161 W	1 kHz, Unclipped (0 dBFS), $T_A = 25^\circ\text{C}$
Output Power, BTL, 6 Ω :	210 W	1 kHz, 10% THD+N, $T_A = 25^\circ\text{C}$
Output Power, BTL, 8 Ω :	122 W	1 kHz, Unclipped (0 dBFS), $T_A = 25^\circ\text{C}$
Output Power, BTL, 8 Ω :	160 W	1 kHz, 10% THD+N, $T_A = 25^\circ\text{C}$
Maximum Peak Current, SE:	>9.9 A	1 kHz Burst, 1 Ω , $R_{OC} = 22\text{ k}$
Maximum Peak Current, BTL:	>9.9 A	1 kHz Burst, 1 Ω , $R_{OC} = 22\text{ k}$
Output Stage Efficiency:	>90%	1 x SE Channels, 4 Ω + 1 x BTL Channel, 8 Ω
Damping Factor SE:	14	1 kHz, Relative to 4- Ω load
Damping Factor BTL:	15	1 kHz, relative to 8- Ω Load
System Supply Current:	<195 mA	1 kHz, -60-dBFS Signal, With TI Input Board
H-Bridge Supply Current:	<190 mA	1 kHz, -60-dBFS Signal
Total Board Idle Power Consumption:	12.5 W	H-Bridge Supply + System Supply, -60-dBFS Signal

Table 7. Audio Performance

Audio Performance			Notes/Conditions
THD+N, SE, 4 Ω :	1 W	<0.09%	1 kHz
THD+N, SE, 4 Ω :	10 W	<0.09%	1 kHz
THD+N, SE, 4 Ω :	50 W	<0.08%	1 kHz
THD+N, BTL, 6 Ω :	1 W	<0.009%	1 kHz
THD+N, BTL, 6 Ω :	10 W	<0.05%	1 kHz
THD+N, BTL, 6 Ω :	50 W	<0.03%	1 kHz
THD+N, BTL, 6 Ω :	100 W	<0.12%	1 kHz
THD+N, BTL, 6 Ω :	150 W	<0.14%	1 kHz
THD+N, BTL, 8 Ω :	1 W	<0.007%	1 kHz
THD+N, BTL, 8 Ω :	10 W	<0.04%	1 kHz
THD+N, BTL, 8 Ω :	50 W	<0.03%	1 kHz
THD+N, BTL, 8 Ω :	100 W	<0.08%	1 kHz
Dynamic Range:		>109 dB	Ref: Rated Power, A-Weighted, AES17 Filter, 4 Ch Avg
Noise Voltage SE:		<50 μ Vrms	A-weighted, AES17 Filter
Noise Voltage BTL:		<100 μ Vrms	A-weighted, AES17 Filter
Channel Separation:		>68 dB	1 kHz
Frequency Response SE (100 Hz–20 kHz):		\pm 0.5 / –1.0 dB	62.5 W / 4 Ω , Unclipped (0 dBFS)
Frequency Response BTL (20 Hz–20 kHz):		\pm 0.3	125 W / 8 Ω , Unclipped (0 dBFS)

Table 8. Thermal Specifications

Thermal Specifications	T _{HEATSINK} ⁽¹⁾	Notes/Conditions
Idle, All Channels Switching	46°C	1 kHz, 15 min, –60-dBFS signal, T _A = 25°C
4 x 7.5 W, 4 Ω + 2 x 16 W, 8 Ω (1/8 power)	66°C	1 kHz, 1 hour, T _A = 25°C
2 x 60 W, 4 Ω	73°C	1 kHz, 5 min, T _A = 25°C

⁽¹⁾ Measured on surface of heatsink.

Table 9. Physical Specifications⁽¹⁾

Physical Specification		Notes/Conditions
PCB Dimensions:	112 x 154 x 54	Width x Length x Height (mm)
Total Weight:	350 g	Components + PCB + Heat-Sink + Mechanics

⁽¹⁾ All electrical and audio specifications are typical values.

4.1 THD+N vs Power (SE –4 Ω)

Gain: 2.5 dB set in TAS5086

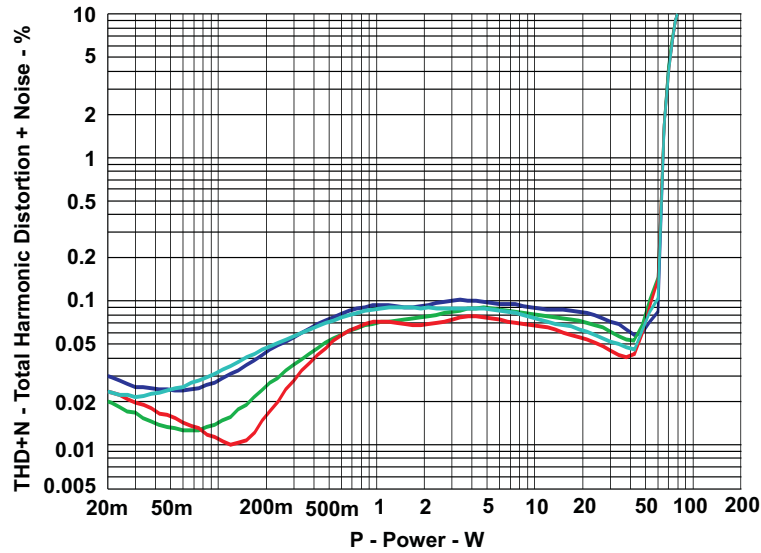

Figure 5. THD+N vs Power (SE –4 Ω)

4.2 THD+N vs Power (SE – 3 Ω)

Gain: 2.5 dB set in TAS5086

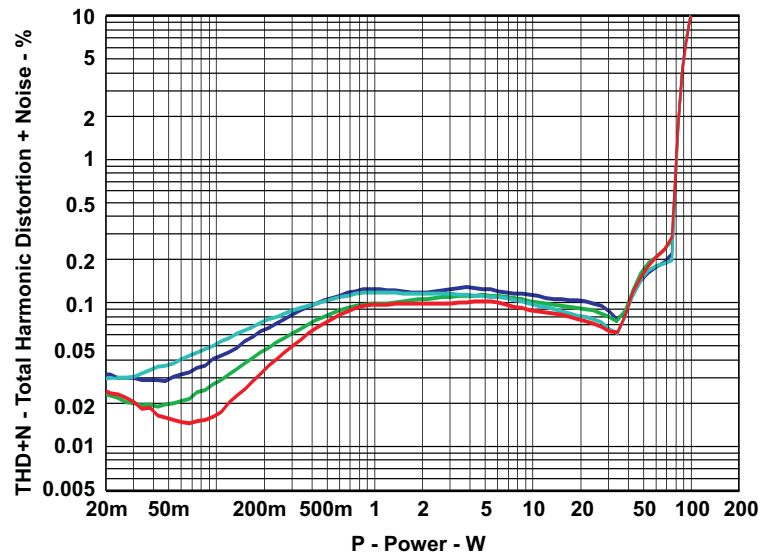

Figure 6. THD+N vs Power (SE – 3 Ω)

4.3 THD+N vs Power (BTL – 8 Ω)

Gain: 2.5 dB set in TAS5086

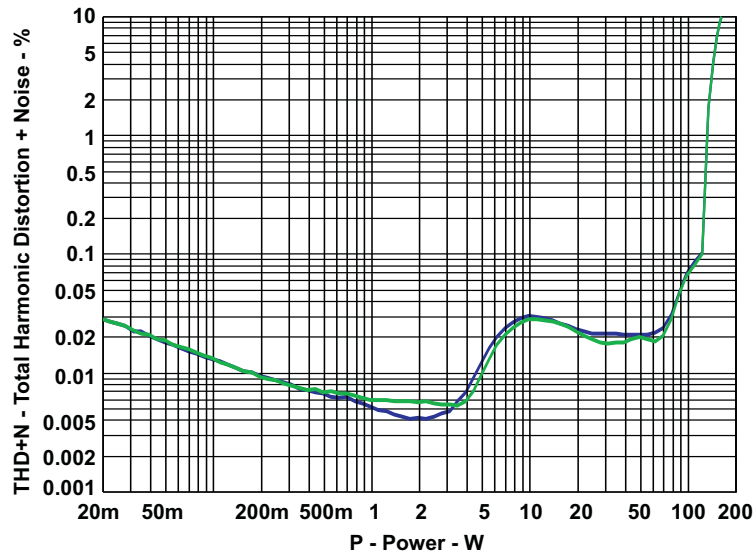

Figure 7. THD+N vs Power (BTL – 8 Ω)

4.4 THD+N vs Power (BTL – 6 Ω)

Gain: 2.5 dB set in TAS5086

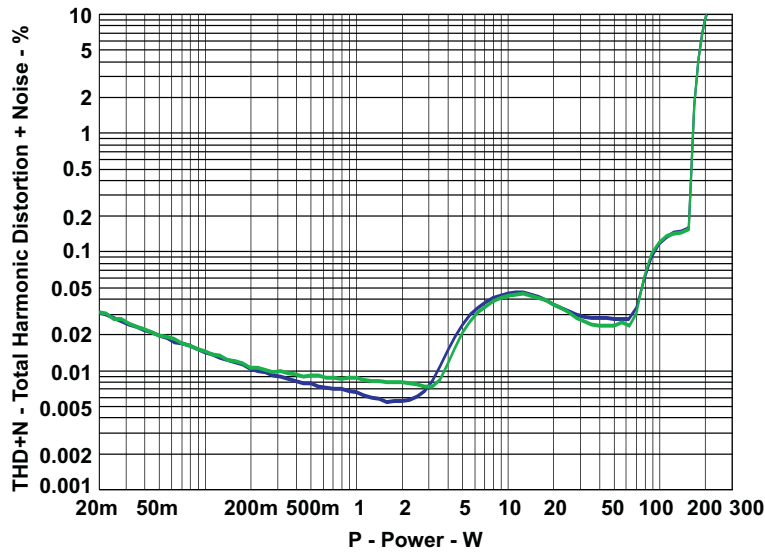

Figure 8. THD+N vs Power (BTL – 6 Ω)

4.5 THD+N vs Frequency (SE – 4 Ω)

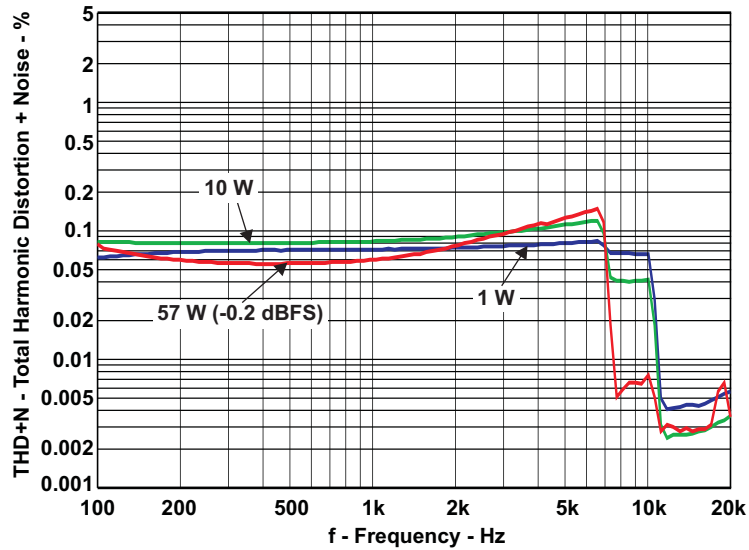

Figure 9. THD+N vs Frequency (SE – 4 Ω)

4.6 THD+N vs Frequency (SE – 3 Ω)

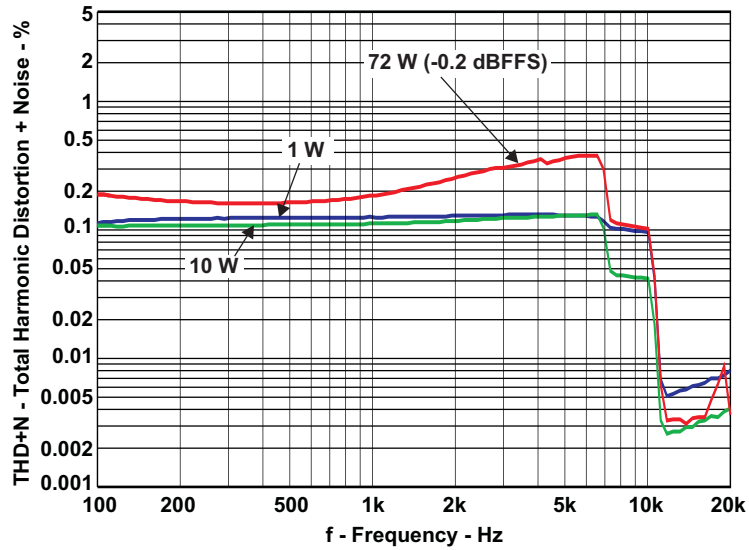

Figure 10. THD+N vs Frequency (SE – 3 Ω)

4.7 THD+N vs Frequency (BTL – 8 Ω)

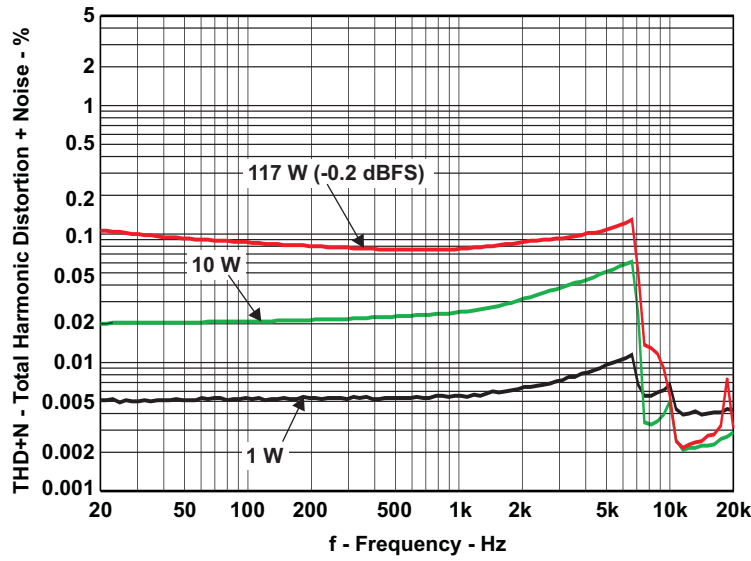

Figure 11. THD+N vs Frequency (BTL – 8 Ω)

4.8 THD+N vs Frequency (BTL – 6 Ω)

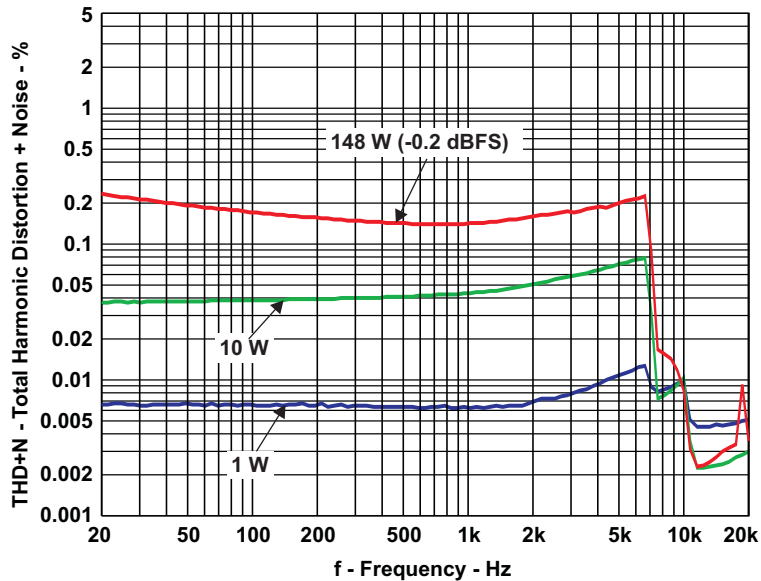

Figure 12. THD+N vs Frequency (BTL – 6 Ω)

4.9 FFT Spectrum With -60-dBFS Tone (SE)

Reference voltage is 15.5 V. FFT size 16 k.

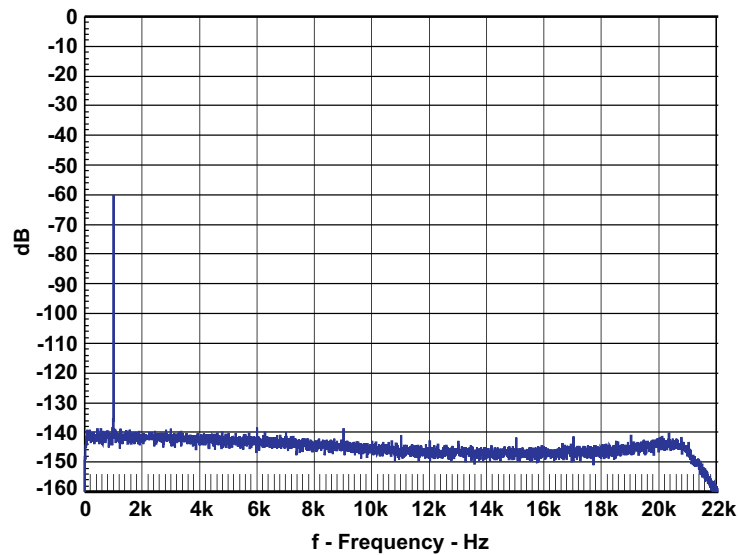

Figure 13. FFT Spectrum With -60 dBFS Tone (SE)

4.10 FFT Spectrum With -60-dBFS Tone (BTL)

Reference voltage is 31.2 V. FFT size 16 k.

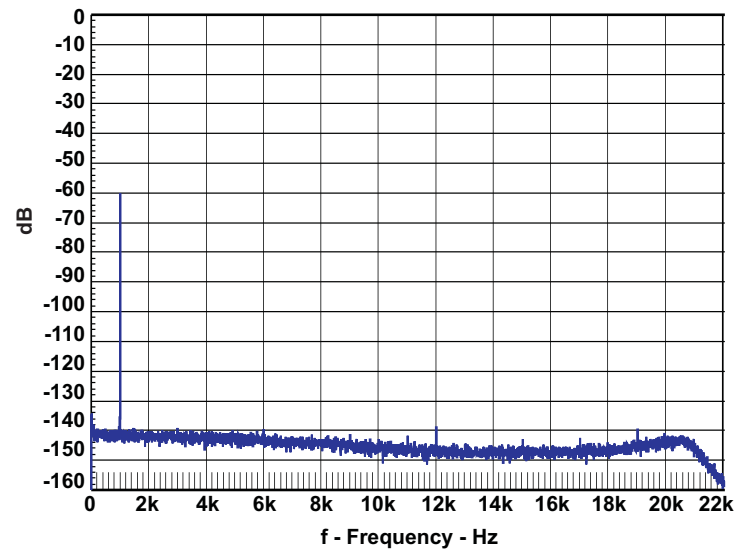

Figure 14. FFT Spectrum With -60-dBFS Tone (BTL)

4.11 Idle Noise FFT Spectrum (SE)

Reference voltage is 15.5 V. FFT size 16 k.

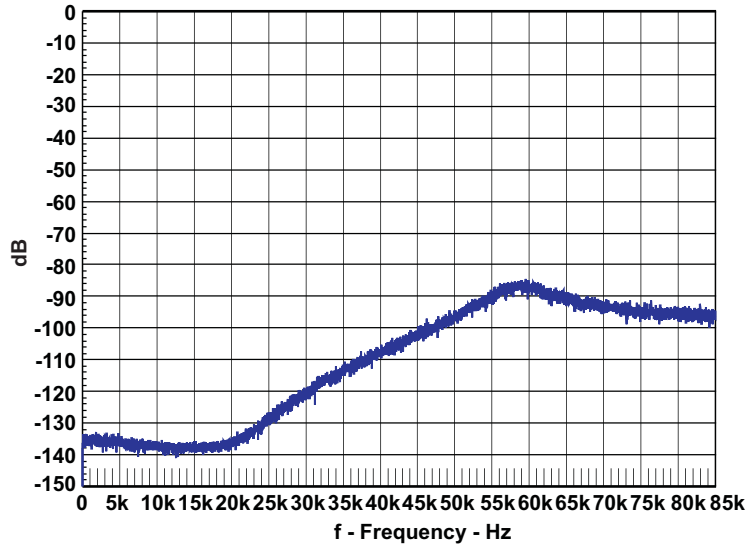

Figure 15. Idle Noise FFT Spectrum (SE)

4.12 Idle Noise FFT Spectrum (BTL)

Reference voltage is 31.2 V. FFT size 16 k.

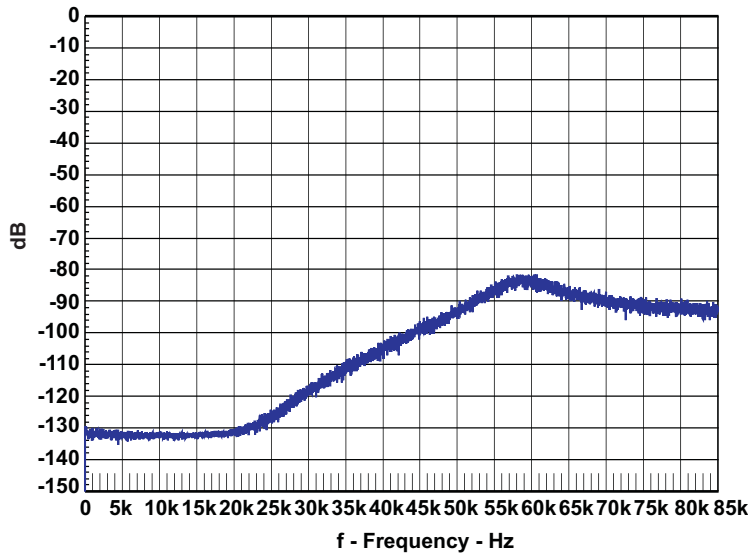

Figure 16. Idle Noise FFT Spectrum (BTL)

4.13 Channel Separation

Channel separation is tested for two channels, channel 1 and channel 2. Both channels use 4-Ω loads. Channel-1 input signal is 0 dBFS, channel 2 is muted. Reference voltage is 15.5 Vrms.

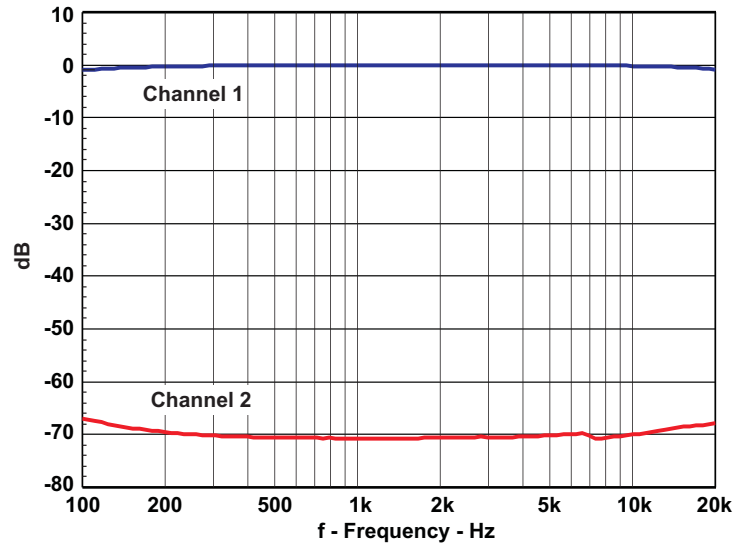

Figure 17. Channel Separation

4.14 Frequency Response (SE)

Measurement bandwidth filter is 80 kHz.

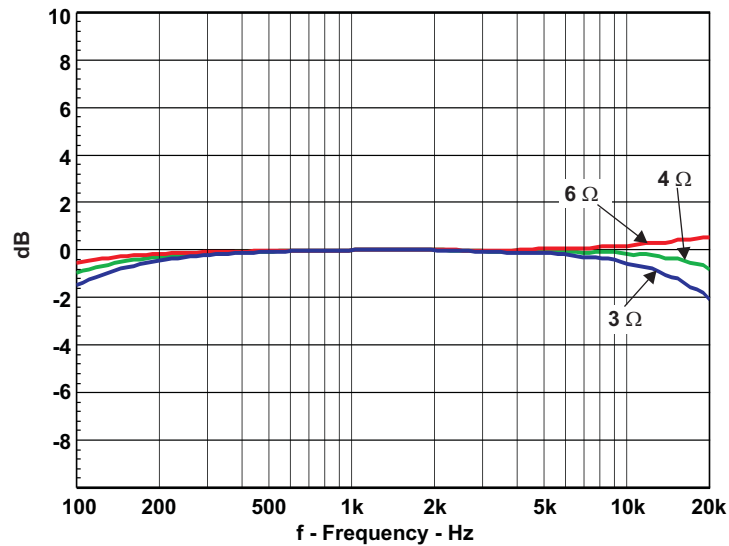

Figure 18. Frequency Response (BTL)

4.15 Frequency Response (BTL)

Measurement bandwidth filter is 80 kHz.

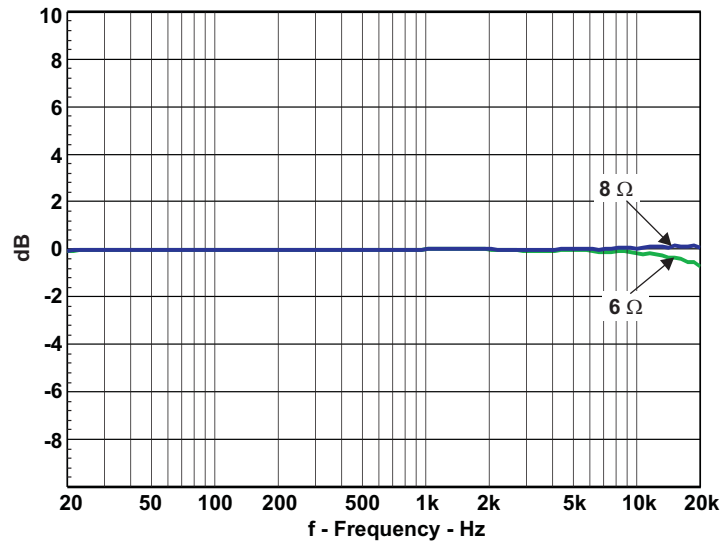

Figure 19. Frequency Response (BTL)

4.16 High-Current Protection (SE)

Input 1-kHz bursted signal, Load 1 Ω.

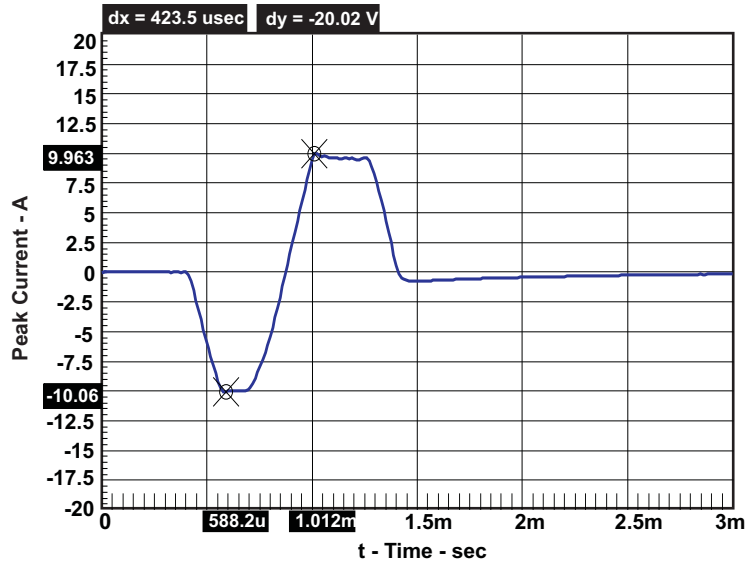

Figure 20. High Current Protection (SE)

4.17 High-Current Protection (BTL)

Input 1-kHz bursted signal, Load 1 Ω .

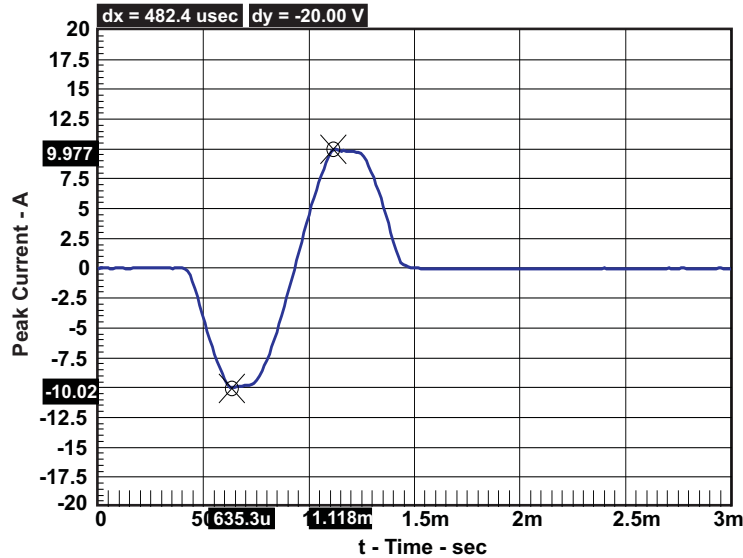

Figure 21. High Current Protection (PBTL)

4.18 Pop/Click (BTL)

No input signal applied, Load 8 Ω . FFT Analyzer Setup: Size = 32768, Window = Blackman Harris, Sample Rate = 48 kHz, DC Coupled.

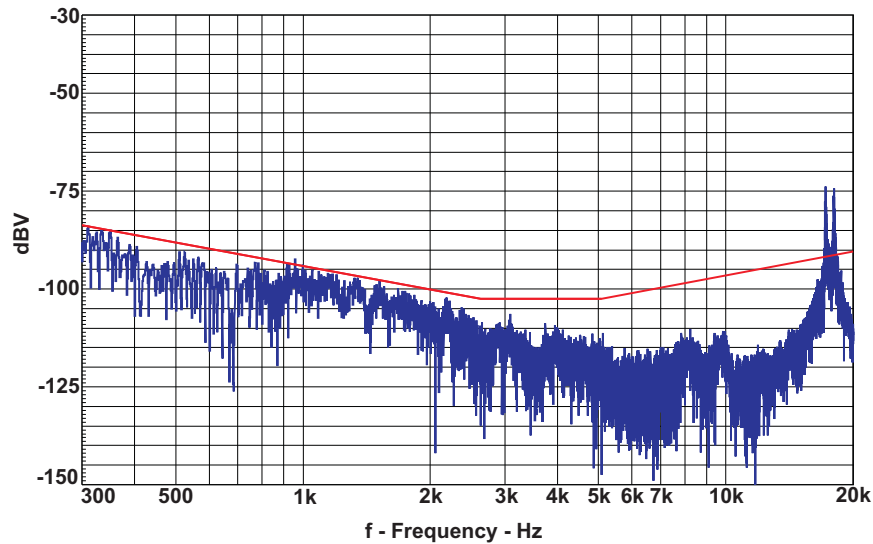

Figure 22. Pop/Click (BTL)

4.19 Pop/Click (SE)

No input signal applied, Load 4 Ω . FFT Analyzer Setup: Size = 32768, Window = Blackman Harris, Sample Rate = 48 kHz, DC Coupled.

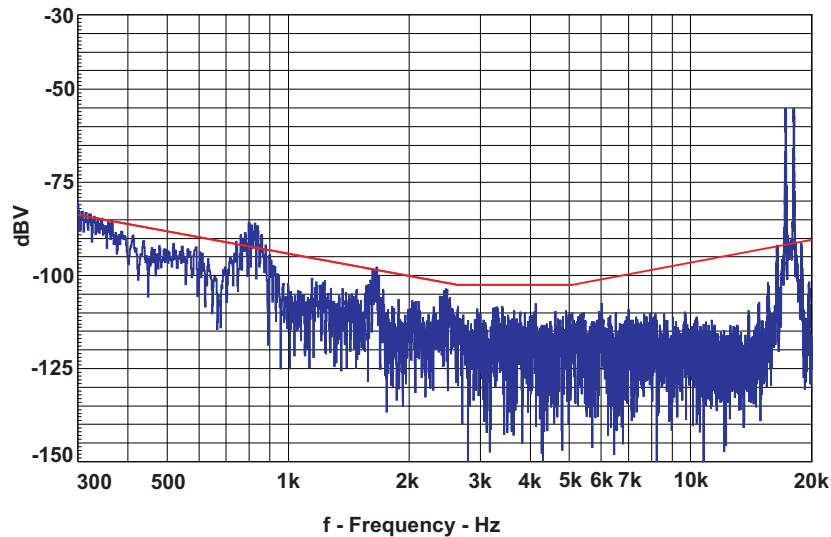

Figure 23. Pop/Click (SE)

4.20 Output Stage Efficiency

Efficiency is tested with one SE channel loaded 4 Ω and one BTL channel loaded with 8 Ω . The board has been preheated for 1 hour at 1/8 output power.

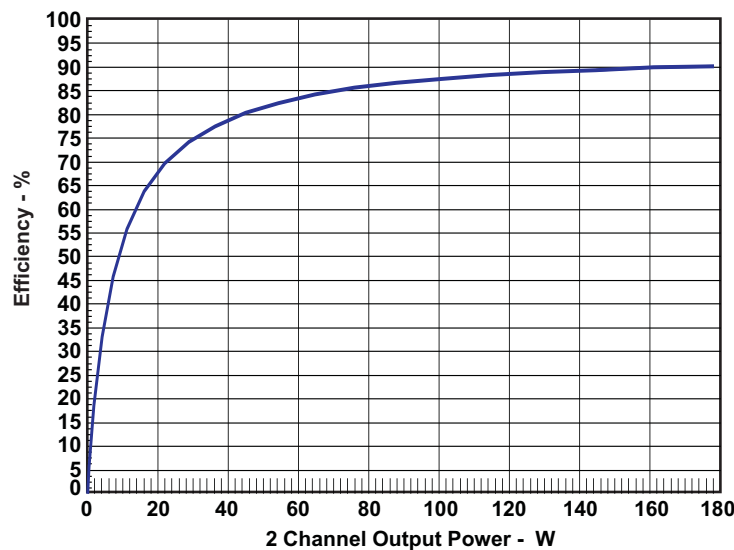

Figure 24. Output Stage Efficiency

5 Related Documentation from Texas Instruments

Table 10 contains a list of data sheets that have detailed descriptions of the integrated circuits used in the design of the TAS5162DDV6EVM. The data sheets can be obtained at <http://www.ti.com>.

Table 10. Related Documentation from Texas Instruments

Part Number	Literature Number
TAS5086	SLES131
TAS5162	SLES194
TLV272	SLOS351
TPS5430	SLVS632
TPS3801K33	SLVS219
TLV2217-33	SLVS067
UA78M12	SLVS059

5.1 Additional Documentation

1. *PC Configuration Tool for TAS5086* (TAS5086 GUI ver. 4.0 or later)
2. *System Design Considerations for True Digital Audio Power Amplifiers* ([SLAA117](#))
3. *Digital Audio Measurements* ([SLAA114](#))
4. *PSRR for PurePath Digital™ Audio Amplifiers* ([SLEA049](#))
5. *Power Rating in Audio Amplifier* ([SLEA047](#))
6. *PurePath Digital™ AM Interference Avoidance* ([SLEA040](#))
7. *Click and Pop Measurement Technique* ([SLEA044](#))
8. *Power Supply Recommendations for DVD Receivers* ([SLEA027](#))
9. *Implementation of Power Supply Volume Control* ([SLEA038](#))

Appendix A Design Documents

This appendix comprises design documents pertaining to the TAS5162DDV6EVM evaluation module. The documents are presented in the following order.

- Schematic (6 pages)
- Parts List (2 pages)
- PCB Specification (1 page)
- PCB Layers (4 pages)
- Heat-Sink Drawing (1 page)



Design Name: **TAS5162DDV6EVM**
 Type: Mass Market Evaluation Module
 File Name: A816-SCH-001(4.00).DSN
 Version: 4.00
 Date: 7.September 2007
 Design Engineer: Jonas L. Holm (jlh@ti.com)
 Audio Configuration: 5.1 PurePath Digital Amplifier Design
 1 x TAS5086, 2 x TAS5162DDV

Interfaces: J40: 34 pin IDC Header for Control, I2C and +5V
 J60: 16 pin IDC Header for I2S Audio
 J101-J106: 2 pin 3.96mm Headers for Speakers
 J901: 4 pin 3.96mm Header for H-Bridge and System Power Supply

Setup: 4 x 4 Ohm and 2 x 8 Ohm Speaker Loads
 +50V H-Bridge and +15V System Power Supplies

Performance: 4 x 62.5 W/4 Ohm (SE) + 2 x 125 W/8 Ohm (BTL) - all unclipped.
 105 dB Dynamic Range

Page

- 1/6: Front Page and Schematic Disclaimer
- 2/6: Overview - Modulator and Input/Output
- 3/6: 4 Channel SE Power Stage (FL, FR, SL, and SR)
- 4/6: 2 Channel BTL Power Stage (C and LFE SW)
- 5/6: Power Supplies
- 6/6: Mechanics

Copyright 2007 Texas Instruments, Inc - All rights reserved - The "TI" and "PurePath Digital" logos are trademarks of Texas Instruments.

NOTE1

SCHEMATIC DISCLAIMER

The schematic information and materials ("Materials") provided here are provided by Texas Instruments Incorporated ("TI") as a service to its customers and/or suppliers, and may be used for informational purposes only, and only subject to the following terms. By downloading or viewing these Materials, you are signifying your assent to these terms.

- 1.) These evaluation schematics are intended for use for **ENGINEERING DEVELOPMENT AND EVALUATION PURPOSES ONLY** and are not considered by Texas Instruments to be fit as a basis for establishing production products or systems. This information may be incomplete in several respects, including but not limited to information relating to required design, marketing, and/or manufacturing-related protective considerations and product safety measures typically found in the end-product incorporating the goods.
- 2.) Accordingly, neither TI nor its suppliers warrant the accuracy or completeness of the information, text, graphics, links or other items contained within the Materials. TI may make changes to the Materials, or to the products described therein, at any time without notice. TI makes no commitment to update the Materials.
- 3.) TI assumes no liability for applications assistance, customer product design, software performance, or services that may be described or referenced in the Materials. The user assumes all responsibility and liability for proper and safe design and handling of goods. Accordingly, the user indemnifies TI from all claims arising from its use of the Materials.
- 4.) TI currently deals with various customers for products, and therefore our arrangement with the user will not be exclusive. TI makes no representations regarding the commercial availability of non-TI components that may be referenced in the Materials.
- 5.) No license is granted under any patent right or other intellectual property right of TI covering or relating to any combination, machine, or process in which such TI products or services might be or are used. Except as expressly provided herein, TI and its suppliers do not grant any express or implied right to you under any patents, copyrights, trademarks, or trade secret information.
- 6.) Performance tests and ratings, to the extent referenced in the Materials, are measured using specific computer systems and/or components and reflect the approximate performance of TI products as measured by those tests. Any difference in system hardware or software design or configuration may affect actual performance. Buyers should consult other sources of information to evaluate the performance of systems or components they are considering purchasing.
- 7.) Resale of TI's products or services with statements different from or beyond the parameters stated by TI for that product or service in official TI data books or data sheets voids all express and any implied warranties for the associated TI product or service, and is an unfair and deceptive business practice, and TI is not responsible for any such use.
- 8.) The Materials are copyrighted and any unauthorized use may violate copyright, trademark, and other laws. You may only download one copy for your internal use only, unless you are specifically licensed to do otherwise by TI in writing. This is a license, not a transfer of title, and is subject to the following restrictions: You may not: (a) modify the Materials (including any associated warranties, conditions, limitations or notices) or use them for any commercial purpose, or any public display, performance, sale or rental; (b) decompile, reverse engineer, or disassemble software Materials except and only to the extent permitted by applicable law; (c) remove any copyright or other proprietary notices from the Materials; (d) transfer the Materials to another person. You agree to prevent any unauthorized copying of the Materials. TI may terminate this license at any time if you are in breach of the terms of this Agreement. Upon termination, you will immediately destroy the Materials.
- 9.) **THE MATERIALS ARE PROVIDED "AS IS" WITHOUT ANY EXPRESS OR IMPLIED WARRANTY OF ANY KIND INCLUDING WARRANTIES OF MERCHANTABILITY, NONINFRINGEMENT OF INTELLECTUAL PROPERTY, OR FITNESS FOR ANY PARTICULAR PURPOSE. IN NO EVENT SHALL TI OR ITS SUPPLIERS BE LIABLE FOR ANY DAMAGES WHATSOEVER (INCLUDING, WITHOUT LIMITATION, DAMAGES FOR LOSS OF PROFITS, BUSINESS INTERRUPTION, LOSS OF INFORMATION) ARISING OUT OF THE USE OF OR INABILITY TO USE THE MATERIALS, EVEN IF TI HAS BEEN ADVISED OF THE POSSIBILITY OF SUCH DAMAGES.**

Not Used

POWER OUTPUT STAGE (SE)

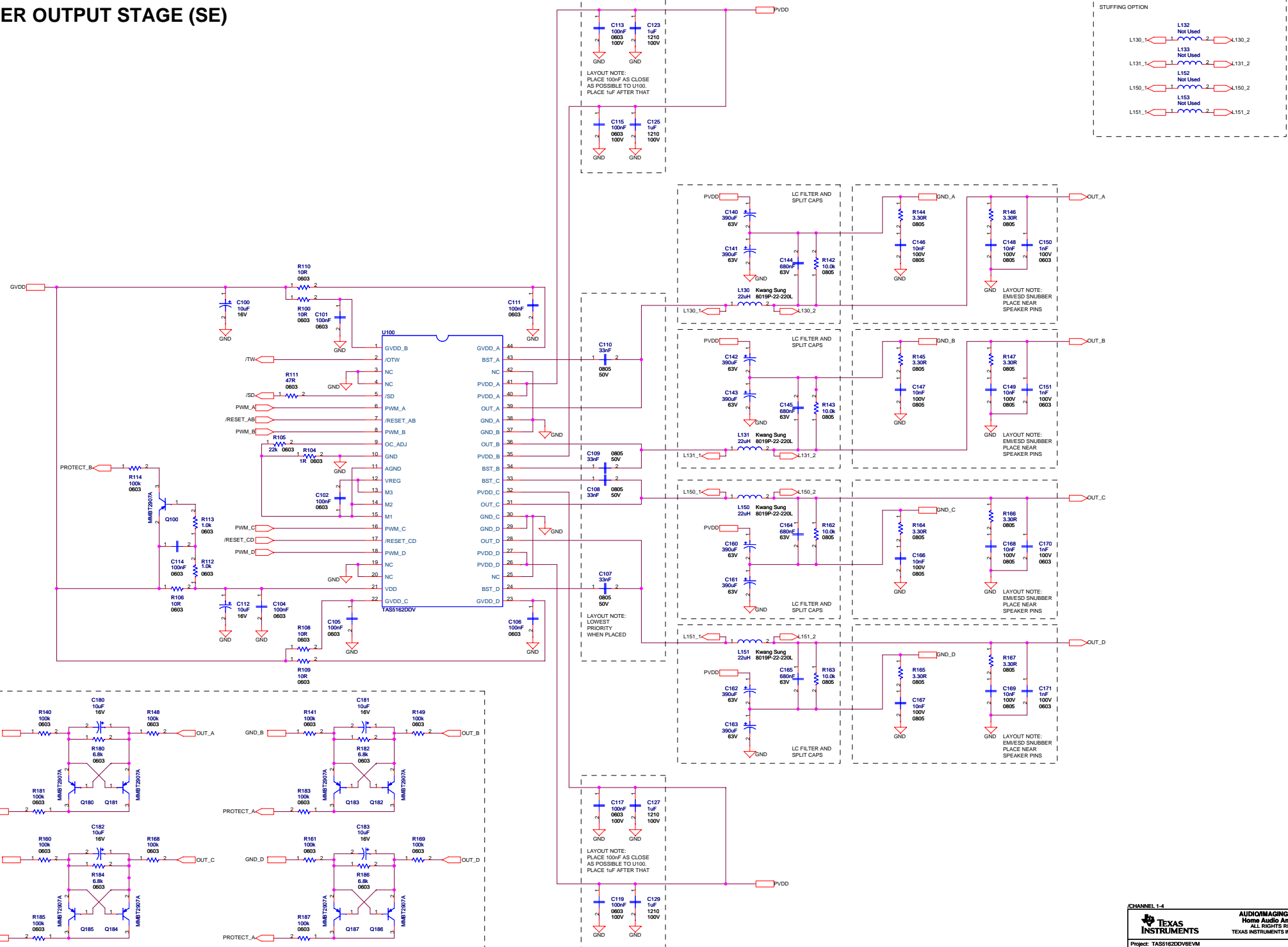

DESIGN NOTE:
IF PVDD < 35V, THEN R180 = R182 = R184 = R186 = 30k Ohm

Patents pending in circuitry design and layout (WO99/59241 & WO99/59242). This circuitry may only be used together with the integrated circuit TAS5162DDV from Texas Instruments Incorporated.

		AUDIOIMAGING GROUP Home Audio Amplifiers ALL RIGHTS RESERVED TEXAS INSTRUMENTS INCORPORATED	
Project: TAS5162DDV6EVM	Rev: 4.00		
Page Title: SE Power Stages	Size: A2		
File Name: A816-SC4-001.DSN	Engineer: Jonas L. Hoem		
Date: Thursday, July 12, 2007	Page: 3 of 6		

POWER OUTPUT STAGE (BTL)

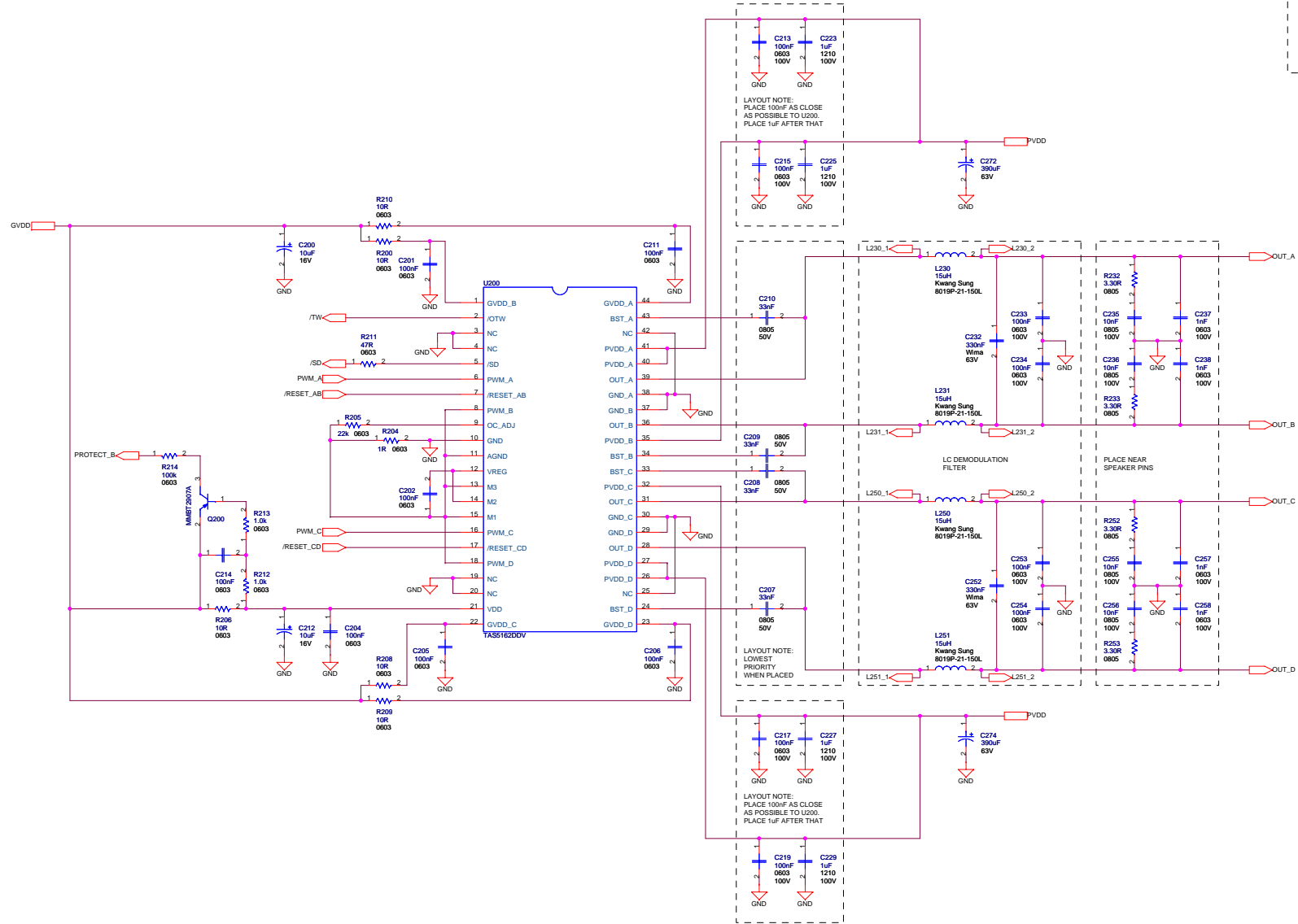
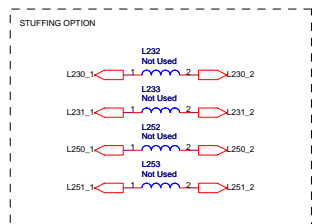

Patents pending in circuitry design and layout (WO99/59241 & WO99/59242). This circuitry may only be used together with the integrated circuit TAS5162DDV from Texas Instruments Incorporated.

CHANNEL 6-6		Parts List 4.00	
		AUDIO/IMAGING GROUP Home Audio Amplifiers ALL RIGHTS RESERVED TEXAS INSTRUMENTS INCORPORATED	
		Project: TAS5162DDV6EVM	Rev: 4.00
Page Title: BTL Power Stages		Size: A2	
File Name: A816-SC4-001.DSN		Engineer: Jonas L. Holm	
Date: Thursday, July 12, 2007		Page: 4 of 6	

POWER SUPPLIES

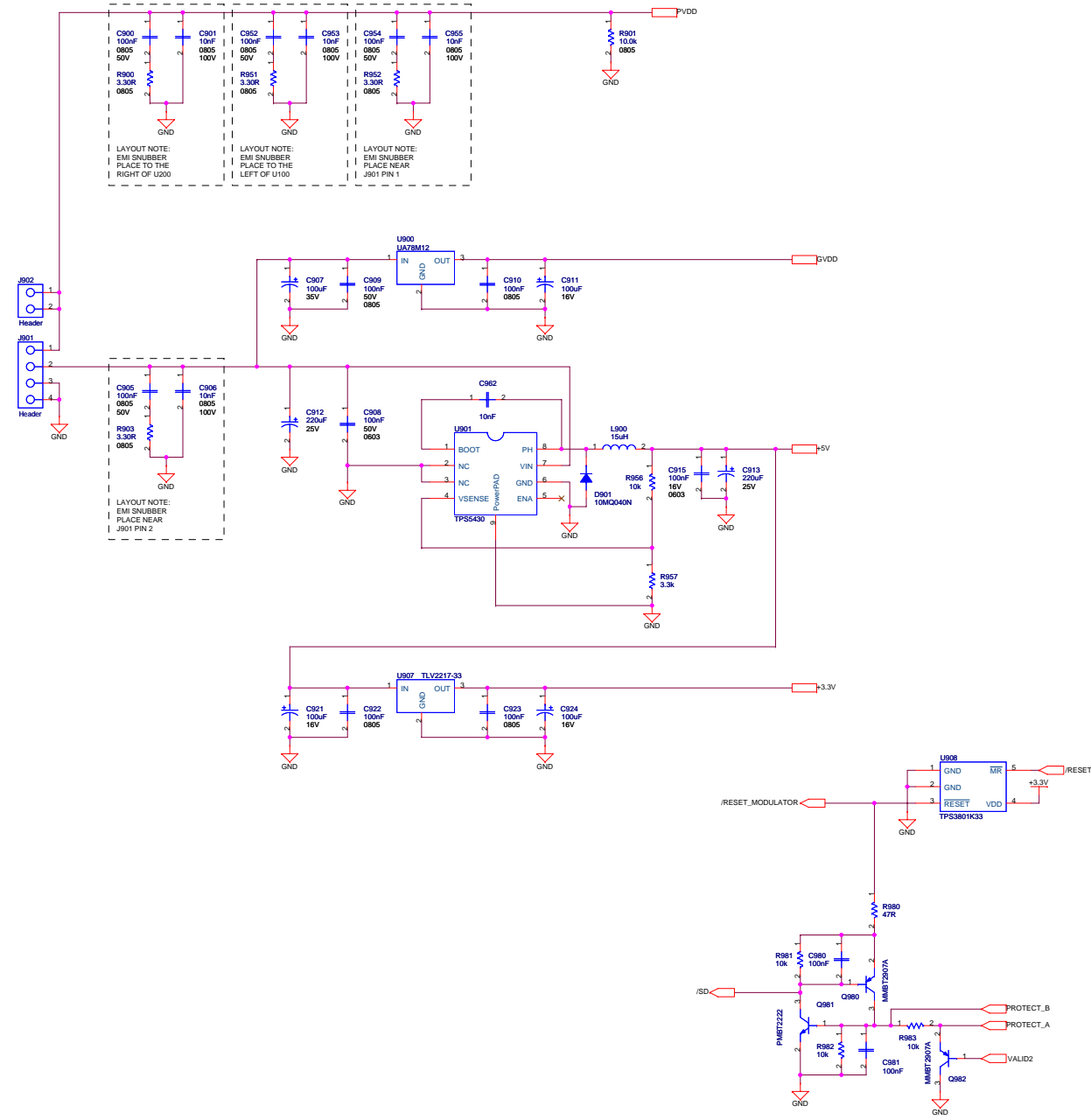

MECHANICS

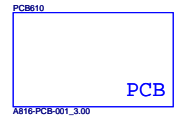
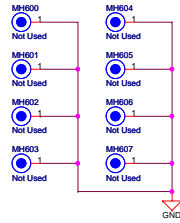
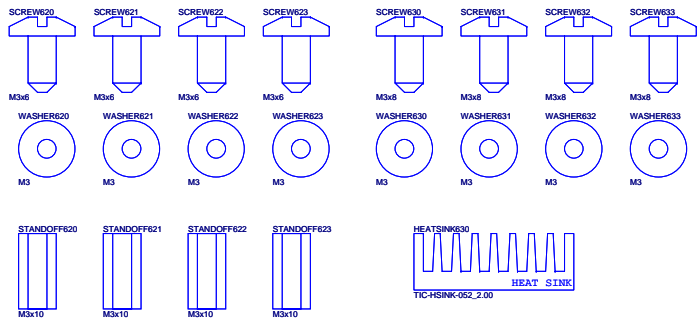

TAS5162DDV6EVM Parts List (4.00)



Qty	Part Reference	Description	Manufacture	First Mfr P/N
5	R142 R143 R162 R163 R901	10.0k / 125mW / 1% / 0805 Thick Film Resistor	Yageo	RC0805FR-0710KL
16	R144 R145 R146 R147 R164 R165 R166 R167 R232 R233 R252 R253 R900 R903 R951 R952	3.30R / 125mW / 1% / 0805 Thick Film Resistor	Yageo	RC0805FR-073R3L
4	R112 R113 R212 R213	1.0k / 100mW / 5% / 0603 Thick Film Resistor	Yageo	RC0603JR-071KL
19	R40 R41 R42 R43 R44 R45 R46 R47 R67 R68 R69 R70 R71 R72 R73 R956 R981 R982 R983	10k / 100mW / 5% / 0603 Thick Film Resistor	Yageo	RC0603JR-0710KL
14	R114 R140 R141 R148 R149 R160 R161 R168 R169 R181 R183 R185 R187 R214	100k / 100mW / 5% / 0603 Thick Film Resistor	Yageo	RC0603JR-07100KL
2	R104 R204	1R / 100mW / 5% / 0603 Thick Film Resistor	Yageo	RC0603JR-071RL
10	R100 R106 R108 R109 R110 R200 R206 R208 R209 R210	10R / 100mW / 5% / 0603 Thick Film Resistor	Yageo	RC0603JR-0710RL
1	R18	18.0k / 100mW / 1% / 0603 Thick Film Resistor	Yageo	RC0603FR-0718KL
2	R10 R11	200R / 100mW / 5% / 0603 Thick Film Resistor	Yageo	RC0603JR-07200RL
2	R105 R205	22k / 100mW / 5% / 0603 Thick Film Resistor	Yageo	RC0603JR-0722KL
1	R957	3.3k / 100mW / 5% / 0603 Thick Film Resistor	Yageo	RC0603JR-073K3L
19	R23 R48 R49 R50 R51 R52 R53 R54 R55 R60 R61 R62 R63 R64 R65 R66 R111 R211 R980	47R / 100mW / 5% / 0603 Thick Film Resistor	Yageo	RC0603JR-0747RL
4	R180 R182 R184 R186	6.8k / 100mW / 5% / 0603 Thick Film Resistor	Yageo	RC0603JR-076K8L
16	C146 C147 C148 C149 C166 C167 C168 C169 C235 C236 C255 C256 C901 C906 C953 C955	Ceramic 10nF / 100V / 20% X7R 0805 Capacitor	BC Components	0805B103M101NT
8	C900 C905 C909 C910 C922 C923 C952 C954	Ceramic 100nF / 50V / 20% X7R 0805 Capacitor	BC Components	0805B104M500NT
8	C107 C108 C109 C110 C207 C208 C209 C210	Ceramic 33nF / 50V / 20% X7R 0805 Capacitor	BC Components	0805B333M500NT
8	C123 C125 C127 C129 C223 C225 C227 C229	Ceramic 1uF / 100V / 10% X7R 1210 Capacitor	Murata	GRM32ER72A105KA01L
8	C150 C151 C170 C171 C237 C238 C257 C258	Ceramic 1nF / 100V / 10% X7R 0603 Capacitor	Murata	GRM188R72A102KA01
3	C10 C13 C962	Ceramic 10nF / 50V / 20% X7R 0603 Capacitor	Vishay	VJ0603Y103MXA
24	C11 C12 C14 C17 C21 C22 C25 C101 C102 C104 C105 C106 C111 C114 C201 C202 C204 C205 C206 C211 C214 C915 C980 C981	Ceramic 100nF / 16V / 20% X7R 0603 Capacitor	Vishay	VJ0603Y104MXJ
1	C908	Ceramic 100nF / 50V / 20% X7R 0603 Capacitor	Vishay	VJ0603Y104MXA
12	C113 C115 C117 C119 C213 C215 C217 C219 C233 C234 C253 C254	Ceramic 100nF / 100V / 10% X7R 0603 Capacitor	Murata	GRM188R72A104KA35D
9	C20 C100 C112 C180 C181 C182 C183 C200 C212	Electrolytic 10uF / 16V / 20% Aluminium 1.5mm ø4mm Ultra-Mini Series Capacitor	Sang Jing Electronics	UMR16V106M4X5
1	C907	Electrolytic 100uF / 35V / 20% Aluminium 3.5mm ø8mm FC Series - Low Impedance Capacitor	Panasonic	EEUFC1V101
3	C911 C921 C924	Electrolytic 100uF / 16V / 20% Aluminium 2.5mm ø6.3mm Ultra-Mini Series Capacitor	Sang Jing Electronics	UMR16V107M6.3X5
2	C912 C913	Electrolytic 220uF / 25V / 20% Aluminium 3.5mm ø8mm FC Series - Low Impedance Capacitor	Panasonic	EEUFC1E221
10	C140 C141 C142 C143 C160 C161 C162 C163 C272 C274	Electrolytic 390uF / 63V / 20% Aluminium 5mm ø12.5mm FC Series - Low Impedance Capacitor	Panasonic	EEUFC1J391
2	C232 C252	Metal Film 330nF / 63V / 10% Polyester 5mm (W:4.5mm L:7.2mm) Capacitor	Wima	MKS 2 0.33uF/10%/63Vdc PCM5
4	C144 C145 C164 C165	Metal Film 680nF / 63V / 10% Polyester 5mm (W:4.5mm L:7.2mm) Capacitor	Wima	MKS 2 0.68uF/10%/63Vdc PCM5
4	L230 L231 L250 L251	15uH / Ferrite Inductor	Kwang Sung	8019P-21-150L
1	L900	15uH / Ferrite Inductor	Kwang Sung	8020P-06-150L
4	L130 L131 L150 L151	22uH / Ferrite Inductor	Kwang Sung	8019P-22-220L
1	D901	1A / 40V Schottky 10MQ040N Diode (SMA)	Int. Rectifier	10MQ040N
1	Q981	600mA / 40V NPN Small signal PMBT2222 Transistor (SOT-23)	Philips	PMBT2222
12	Q100 Q180 Q181 Q182 Q183 Q184 Q185 Q186 Q187 Q200 Q980 Q982	800mA / 40V PNP Small signal MMBT2907A Transistor (SOT-23)	Fairchild	MMBT2907A
1	U10	TAS5086DBT / 6 ch PWM processor (SE, VOL, 192kHz, I2S out) (TSSOP38)	Texas Instruments	TAS5086DBT
2	U100 U200	TAS5162DDV / 4ch/2ch/1ch Digital Audio PWM Power Output Stage (DDV44)	Texas Instruments	TAS5162DDV
1	U908	TPS3801K33 / 3.3V Supply Voltage Supervisor (SOT323-5)	Texas Instruments	TPS3801K33DCK
1	U900	UA78M12 / 12V/500mA Positive Voltage Regulator (PFM2-KTP)	Texas Instruments	UA78M12CKTPR

TAS5162DDV6EVM Parts List (4.00)



1	U907	TLV2217-33 / 3.3V Low Dropout Voltage Regulator (PFM2-KTP)	Texas Instruments	TLV2217-33KTPR
1	U901	TPS5430 / 5V/3A Buck Converter (HSOP8-DDA)	Texas Instruments	TPS5430DDA
4	SCREW620 SCREW621 SCREW622 SCREW623	M3x6 Pan Head, Pozidriv, A2 Screw	Bossard	BN 81882 M3x6
4	SCREW630 SCREW631 SCREW632 SCREW633	M3x8 Pan Head, Pozidriv, A2 Screw	Bossard	BN 81882 M3x8
4	WASHER620 WASHER621 WASHER622 WASHER623	M3 Stainless Steel Washer	Bossard	BN 670 M3
4	WASHER630 WASHER631 WASHER632 WASHER633	M3 Stainless Steel Spring Washer	Bossard	BN 760 M3
4	STANDOFF620 STANDOFF621 STANDOFF622 STANDOFF623	M3x10 Aluminium Stand-off	Ettinger	05.03.108
7	J101 J102 J103 J104 J105 J106 J902	2 pins / 1 row / 3.96mm Pitch Vertical Male Pin header Header	JST	B2P-VH
1	J901	4 pins / 1 row / 3.96mm Pitch Vertical Male Pin header Header	JST	B4P-VH
1	J60	16 pins / 2 rows / 2.54mm Pitch Vertical Male IDC 16 pins IDC Box header	Molex	87256-1611
1	J40	34 pins / 2 rows / 2.54mm Pitch Vertical Male IDC 34 pins IDC Box header	Molex	87256-3411
1	PCB610	A816-PCB-001_4.00 / TAS5162DDV6EVM Printed Circuit Board (ver. 4.00)	Printline	A816-PCB-001(4.00)
1	HEATSINK630	TIC-HSINK-052_2.00 / Heatsink for 2 DDV packages length 106 mm	THF-Teknik	TIC-HSINK-052(2.00)

TAS5162DDV6EVM

PCB SPECIFICATION

Version 4.00

BOARD IDENTIFICATION:	A816-PCB-001(4.00)
BOARD TYPE:	DOUBLE-SIDED PLATED-THROUGH BOARD
LAMINATE TYPE:	FR4
LAMINATE THICKNESS:	1.6mm
COPPER THICKNESS:	70 μm (INCL. PLATING EXTERIOR LAYER)
COPPER PLATING OF HOLES:	>25 μm
MINIMUM HOLE DIAMETER	0.3 mm
SILKSCREEN COMPONENT SIDE:	WHITE - REMOVE SILKSCREEN FROM SOLDER AREA & PRE-TINNED AREAS
SILKSCREEN SOLDER SIDE:	None
SOLDER MASK COMPONENT SIDE:	GREEN
SOLDER MASK SOLDER SIDE:	GREEN
PROTECTIVE COATING:	SOLDER COATING AND CHEMICAL SILVER ON FREE COPPER
ELECTRICAL TEST:	PCB MUST BE ELECTRICAL TESTED
MANUFACTURED TO:	PERFAG 2E (www.perfag.dk)
APERTURE TABLE:	PERFAG 10A (www.perfag.dk)
BOARD SIZE:	112 x 154 mm
Aprox. Number of holes	600
COMMENTS:	SEE DRILL INFORMATION FILE (5201pcb.PDF).

COMPONENT SIDE	dps 5201 070821
TI Denmark A816-PCB-001 (4.00)	

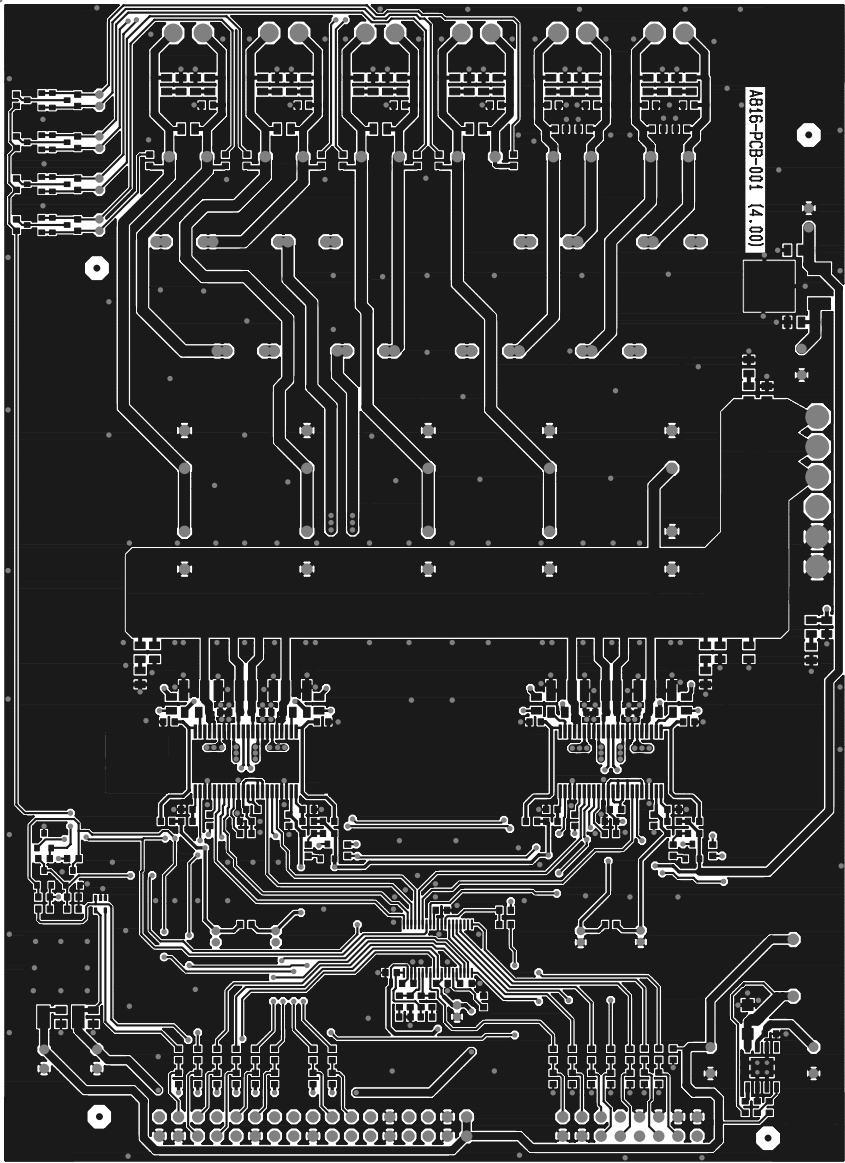

COMP. LAYOUT COMP | DpS 5201 070821

TI Denmark A816-PCB-001 (4.00)

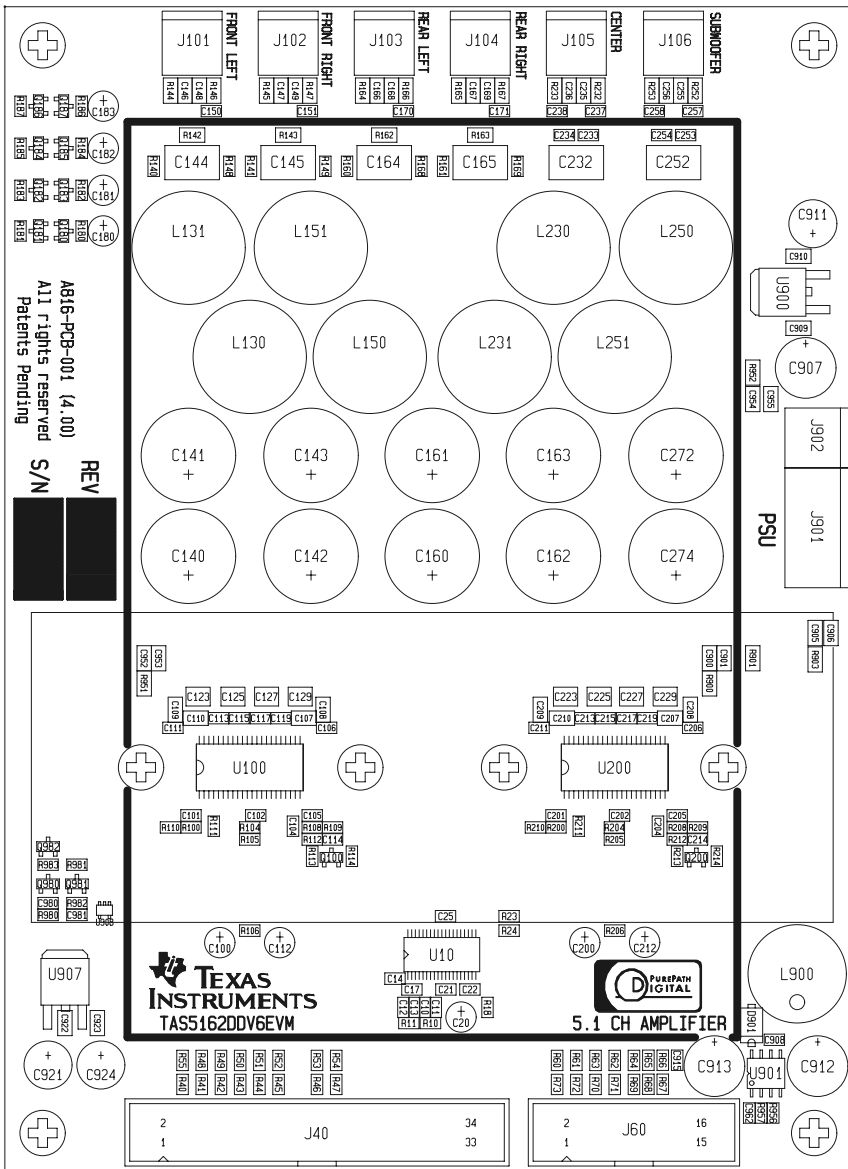

COMP/PCB LAYOUTS/COMP | Dps 5201 070821

TI Denmark A816-PCB-001 (4.00)

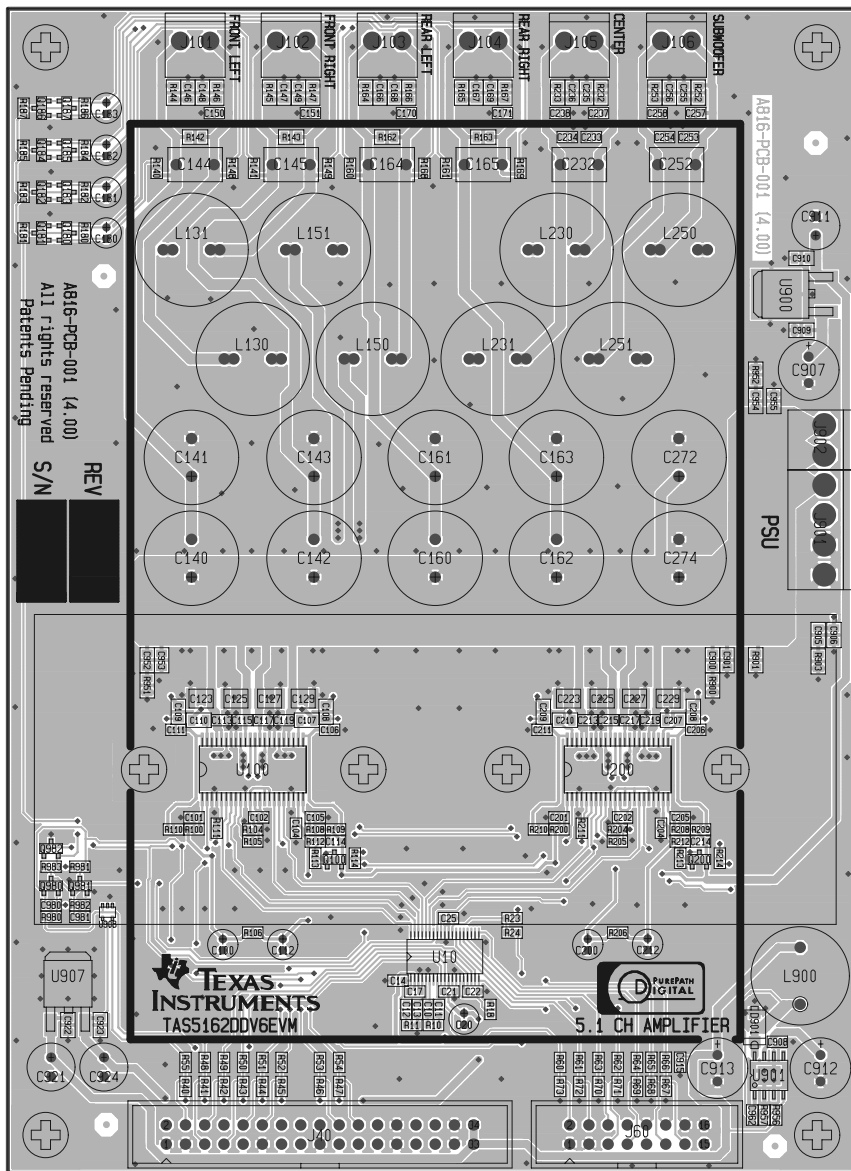

TI Denmark A819-PCB-001 (V.00)	SOLDER SIDE	070821 2501 2501
--------------------------------	-------------	------------------

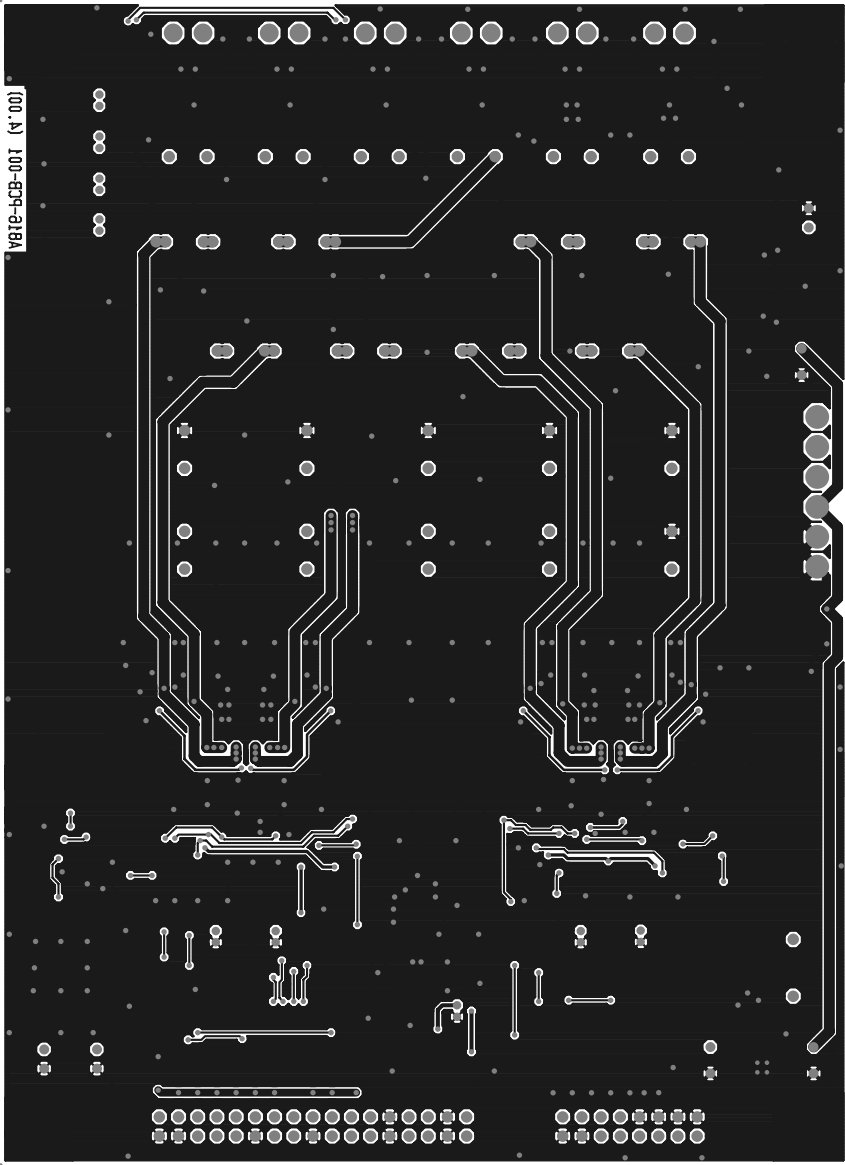

TIC-HSINK-052(2.00)

Heatsink for 2 DDV packages length 106 mm

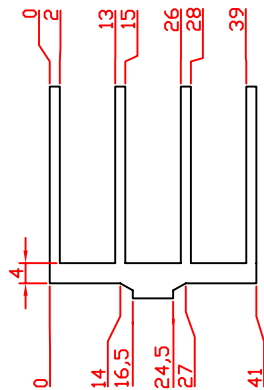
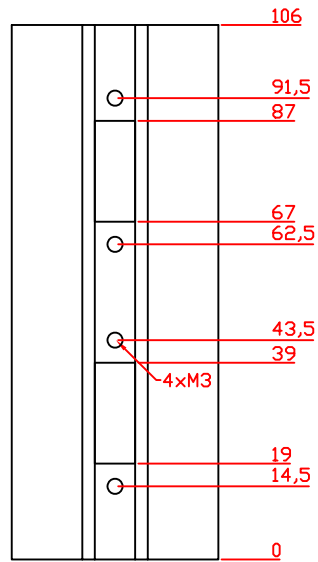

SCALE: 1:1.5
PROFILE: TIC-HSINK-050(1.00)
DIMENSIONS: mm
MATERIAL: ALUMINUM
INTERNAL SCREW THREADS: M3
SURFACE: FREE OF SHARP EDGES
SURFACE TREATMENT: BLACK ANODIZED
TOLERANCES: +/- 0.1 mm

EVALUATION BOARD/KIT IMPORTANT NOTICE

Texas Instruments (TI) provides the enclosed product(s) under the following conditions:

This evaluation board/kit is intended for use for **ENGINEERING DEVELOPMENT, DEMONSTRATION, OR EVALUATION PURPOSES ONLY** and is not considered by TI to be a finished end-product fit for general consumer use. Persons handling the product(s) must have electronics training and observe good engineering practice standards. As such, the goods being provided are not intended to be complete in terms of required design-, marketing-, and/or manufacturing-related protective considerations, including product safety and environmental measures typically found in end products that incorporate such semiconductor components or circuit boards. This evaluation board/kit does not fall within the scope of the European Union directives regarding electromagnetic compatibility, restricted substances (RoHS), recycling (WEEE), FCC, CE or UL, and therefore may not meet the technical requirements of these directives or other related directives.

Should this evaluation board/kit not meet the specifications indicated in the User's Guide, the board/kit may be returned within 30 days from the date of delivery for a full refund. **THE FOREGOING WARRANTY IS THE EXCLUSIVE WARRANTY MADE BY SELLER TO BUYER AND IS IN LIEU OF ALL OTHER WARRANTIES, EXPRESSED, IMPLIED, OR STATUTORY, INCLUDING ANY WARRANTY OF MERCHANTABILITY OR FITNESS FOR ANY PARTICULAR PURPOSE.**

The user assumes all responsibility and liability for proper and safe handling of the goods. Further, the user indemnifies TI from all claims arising from the handling or use of the goods. Due to the open construction of the product, it is the user's responsibility to take any and all appropriate precautions with regard to electrostatic discharge.

EXCEPT TO THE EXTENT OF THE INDEMNITY SET FORTH ABOVE, NEITHER PARTY SHALL BE LIABLE TO THE OTHER FOR ANY INDIRECT, SPECIAL, INCIDENTAL, OR CONSEQUENTIAL DAMAGES.

TI currently deals with a variety of customers for products, and therefore our arrangement with the user **is not exclusive**.

TI assumes **no liability for applications assistance, customer product design, software performance, or infringement of patents or services described herein.**

Please read the User's Guide and, specifically, the Warnings and Restrictions notice in the User's Guide prior to handling the product. This notice contains important safety information about temperatures and voltages. For additional information on TI's environmental and/or safety programs, please contact the TI application engineer or visit www.ti.com/esh.

No license is granted under any patent right or other intellectual property right of TI covering or relating to any machine, process, or combination in which such TI products or services might be or are used.

FCC Warning

This evaluation board/kit is intended for use for **ENGINEERING DEVELOPMENT, DEMONSTRATION, OR EVALUATION PURPOSES ONLY** and is not considered by TI to be a finished end-product fit for general consumer use. It generates, uses, and can radiate radio frequency energy and has not been tested for compliance with the limits of computing devices pursuant to part 15 of FCC rules, which are designed to provide reasonable protection against radio frequency interference. Operation of this equipment in other environments may cause interference with radio communications, in which case the user at his own expense will be required to take whatever measures may be required to correct this interference.

EVM WARNINGS AND RESTRICTIONS

It is important to operate this EVM within the input voltage range of 3.3 V to 5 V and the output voltage range of 0 V to 5 V.

Exceeding the specified input range may cause unexpected operation and/or irreversible damage to the EVM. If there are questions concerning the input range, please contact a TI field representative prior to connecting the input power.

Applying loads outside of the specified output range may result in unintended operation and/or possible permanent damage to the EVM. Please consult the EVM User's Guide prior to connecting any load to the EVM output. If there is uncertainty as to the load specification, please contact a TI field representative.

During normal operation, some circuit components may have case temperatures greater than 30°C. The EVM is designed to operate properly with certain components above 85°C as long as the input and output ranges are maintained. These components include but are not limited to linear regulators, switching transistors, pass transistors, and current sense resistors. These types of devices can be identified using the EVM schematic located in the EVM User's Guide. When placing measurement probes near these devices during operation, please be aware that these devices may be very warm to the touch.

Mailing Address: Texas Instruments, Post Office Box 655303, Dallas, Texas 75265
Copyright © 2007, Texas Instruments Incorporated

IMPORTANT NOTICE

Texas Instruments Incorporated and its subsidiaries (TI) reserve the right to make corrections, modifications, enhancements, improvements, and other changes to its products and services at any time and to discontinue any product or service without notice. Customers should obtain the latest relevant information before placing orders and should verify that such information is current and complete. All products are sold subject to TI's terms and conditions of sale supplied at the time of order acknowledgment.

TI warrants performance of its hardware products to the specifications applicable at the time of sale in accordance with TI's standard warranty. Testing and other quality control techniques are used to the extent TI deems necessary to support this warranty. Except where mandated by government requirements, testing of all parameters of each product is not necessarily performed.

TI assumes no liability for applications assistance or customer product design. Customers are responsible for their products and applications using TI components. To minimize the risks associated with customer products and applications, customers should provide adequate design and operating safeguards.

TI does not warrant or represent that any license, either express or implied, is granted under any TI patent right, copyright, mask work right, or other TI intellectual property right relating to any combination, machine, or process in which TI products or services are used. Information published by TI regarding third-party products or services does not constitute a license from TI to use such products or services or a warranty or endorsement thereof. Use of such information may require a license from a third party under the patents or other intellectual property of the third party, or a license from TI under the patents or other intellectual property of TI.

Reproduction of TI information in TI data books or data sheets is permissible only if reproduction is without alteration and is accompanied by all associated warranties, conditions, limitations, and notices. Reproduction of this information with alteration is an unfair and deceptive business practice. TI is not responsible or liable for such altered documentation. Information of third parties may be subject to additional restrictions.

Resale of TI products or services with statements different from or beyond the parameters stated by TI for that product or service voids all express and any implied warranties for the associated TI product or service and is an unfair and deceptive business practice. TI is not responsible or liable for any such statements.

TI products are not authorized for use in safety-critical applications (such as life support) where a failure of the TI product would reasonably be expected to cause severe personal injury or death, unless officers of the parties have executed an agreement specifically governing such use. Buyers represent that they have all necessary expertise in the safety and regulatory ramifications of their applications, and acknowledge and agree that they are solely responsible for all legal, regulatory and safety-related requirements concerning their products and any use of TI products in such safety-critical applications, notwithstanding any applications-related information or support that may be provided by TI. Further, Buyers must fully indemnify TI and its representatives against any damages arising out of the use of TI products in such safety-critical applications.

TI products are neither designed nor intended for use in military/aerospace applications or environments unless the TI products are specifically designated by TI as military-grade or "enhanced plastic." Only products designated by TI as military-grade meet military specifications. Buyers acknowledge and agree that any such use of TI products which TI has not designated as military-grade is solely at the Buyer's risk, and that they are solely responsible for compliance with all legal and regulatory requirements in connection with such use.

TI products are neither designed nor intended for use in automotive applications or environments unless the specific TI products are designated by TI as compliant with ISO/TS 16949 requirements. Buyers acknowledge and agree that, if they use any non-designated products in automotive applications, TI will not be responsible for any failure to meet such requirements.

Following are URLs where you can obtain information on other Texas Instruments products and application solutions:

Products		Applications	
Amplifiers	amplifier.ti.com	Audio	www.ti.com/audio
Data Converters	dataconverter.ti.com	Automotive	www.ti.com/automotive
DSP	dsp.ti.com	Broadband	www.ti.com/broadband
Interface	interface.ti.com	Digital Control	www.ti.com/digitalcontrol
Logic	logic.ti.com	Military	www.ti.com/military
Power Mgmt	power.ti.com	Optical Networking	www.ti.com/opticalnetwork
Microcontrollers	microcontroller.ti.com	Security	www.ti.com/security
RFID	www.ti-rfid.com	Telephony	www.ti.com/telephony
Low Power Wireless	www.ti.com/lpw	Video & Imaging	www.ti.com/video
		Wireless	www.ti.com/wireless

Mailing Address: Texas Instruments, Post Office Box 655303, Dallas, Texas 75265
Copyright © 2007, Texas Instruments Incorporated